

AREA
S.F. EXC. EMB.

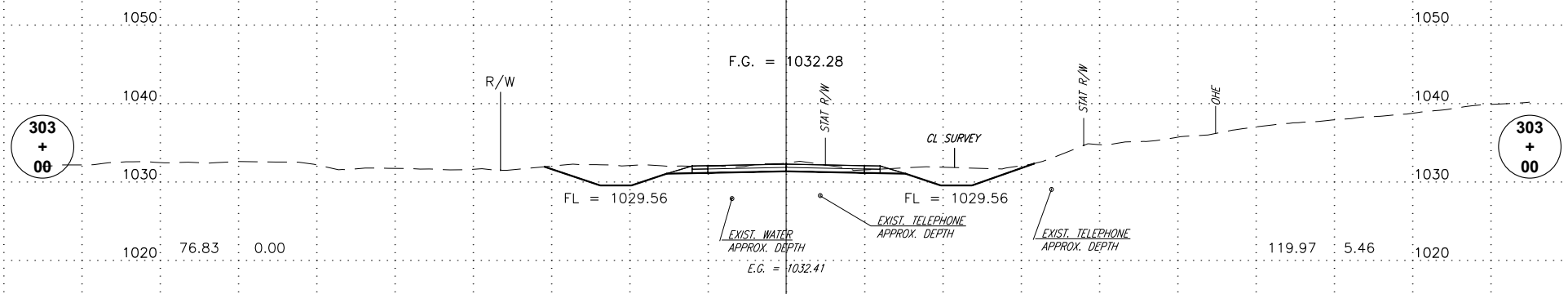
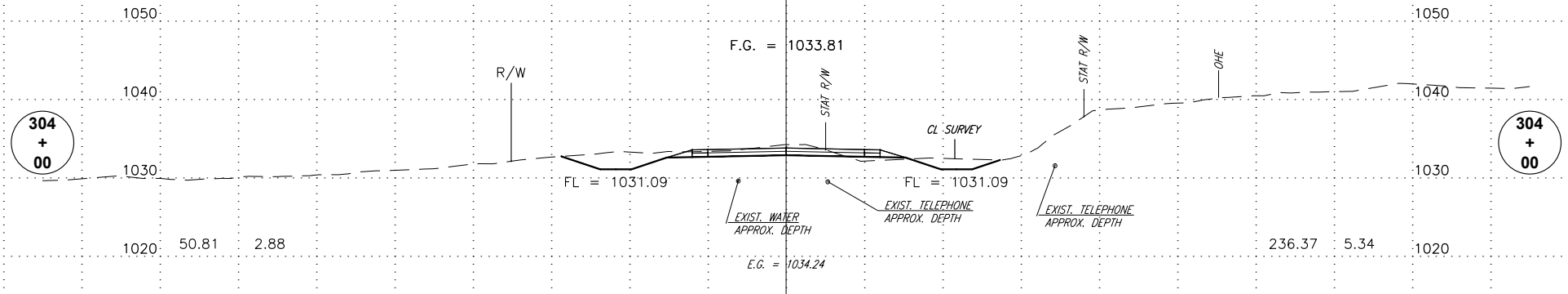
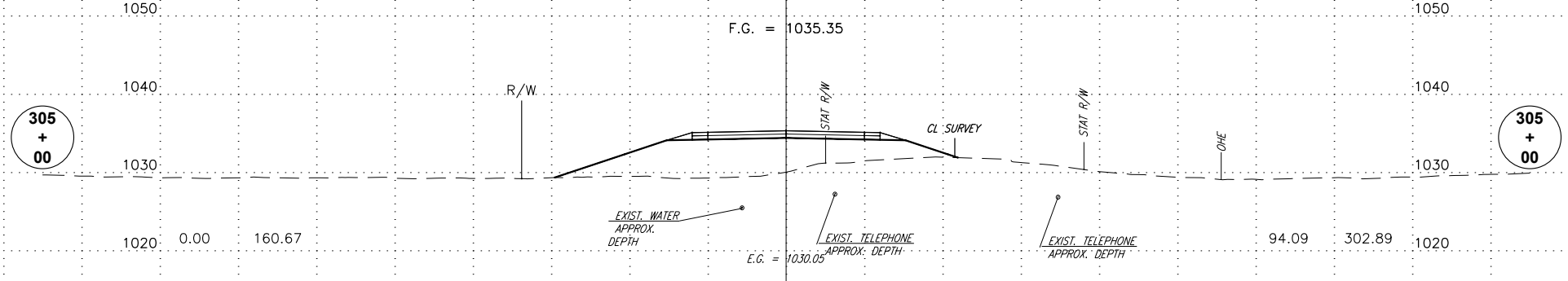
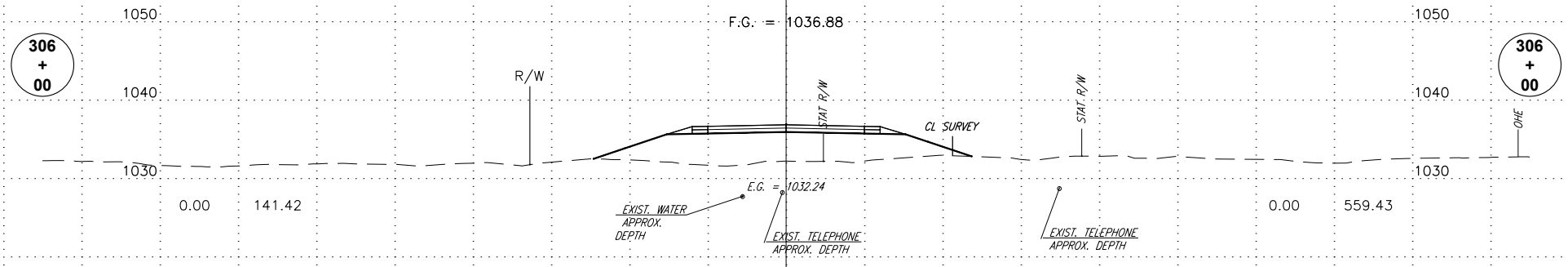
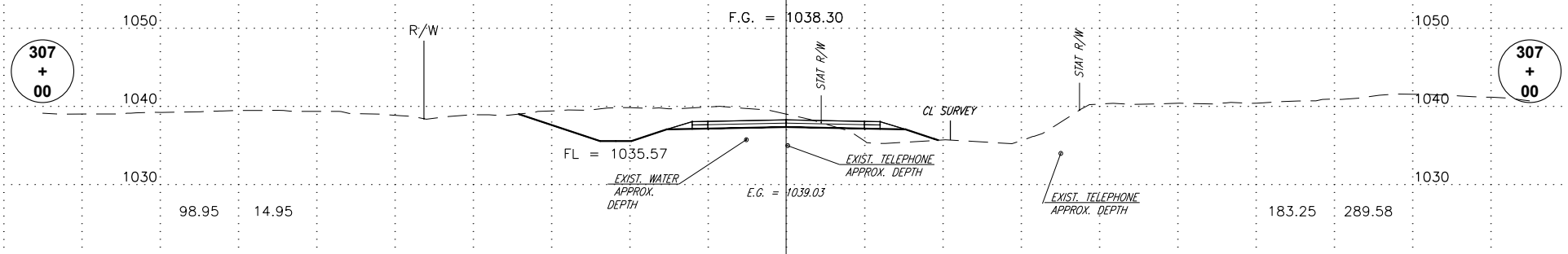
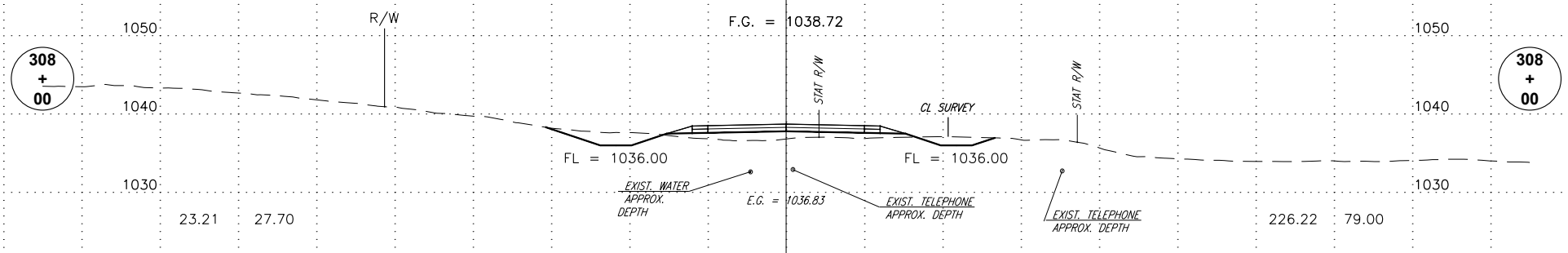

ALL UTILITY LOCATIONS AND DEPTHS ARE APPROXIMATE.

0 5' 10' 20'
FILE: 12010.EW-187 P-BASEMAP.DWG
DATE: 10/18/17 STATE JOB PIECE NO. 27847(04) SHEET NO. X041